

G20SE-XTH

G20 GRIPPERS

Tool less adjustable cable suspension hardware for quick and accurate installs. For multiple suspension applications including lighting, signage, art, acoustical, and displays.

FEATURES/BENEFITS:

- 1) Fast & easy installation. Adjusts quickly by hand. 2) Strength & security. As load increases mechanism grips tighter to cable. 5:1 safety factor. 3) All metal parts. No plastic components. 4) Great Looks. Nickel plated machined brass.



DIMENSIONS:

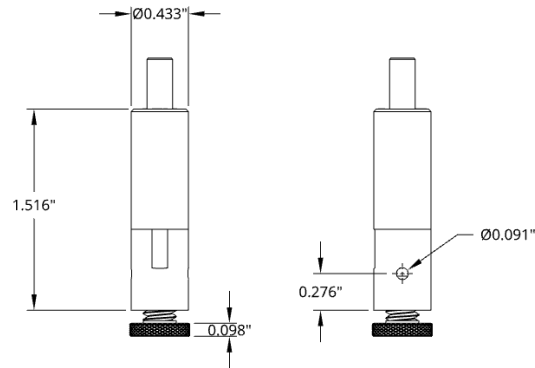

INSTALLATION:

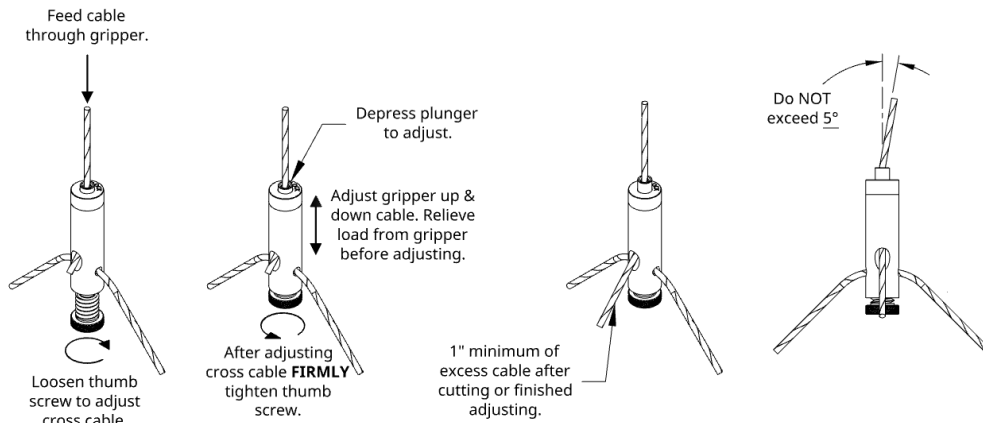

SUBMITTAL INFORMATION:

MATERIAL

- Housing, Top Cap, Thumb Screw & Plunger Release: UNS C3600 Brass Plating: Bright Nickel
- Ball Bearings: Brass
- Spring: 304 Stainless Steel

7x7 Galvanized Cable		
Cable Diameter	1/16"	5/64"
Working Load Limit (lbs)	60	90

7x7 304 Stainless Steel Cable		
Cable Diameter	1/16"	5/64"
Working Load Limit (lbs)	50	75

***WLL 5:1 Safety Factor**

NOT suitable for indoor pools or other chlorinated environments.

