

# G16-14IP-HF

# G16 GRIPPERS

Tool less adjustable cable suspension hardware for quick and accurate installs. For multiple suspension applications including lighting, signage, art, acoustical, and displays.

### FEATURES/BENEFITS:

- 1) Fast & easy installation. Adjusts quickly by hand. 2) Strength & security. As load increases mechanism grips tighter to cable. 5:1 safety factor. 3) All metal parts. No plastic components. 4) Great Looks. Nickel plated machined brass.



### DIMENSIONS:

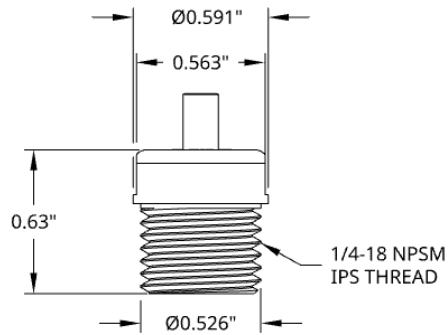

### INSTALLATION:

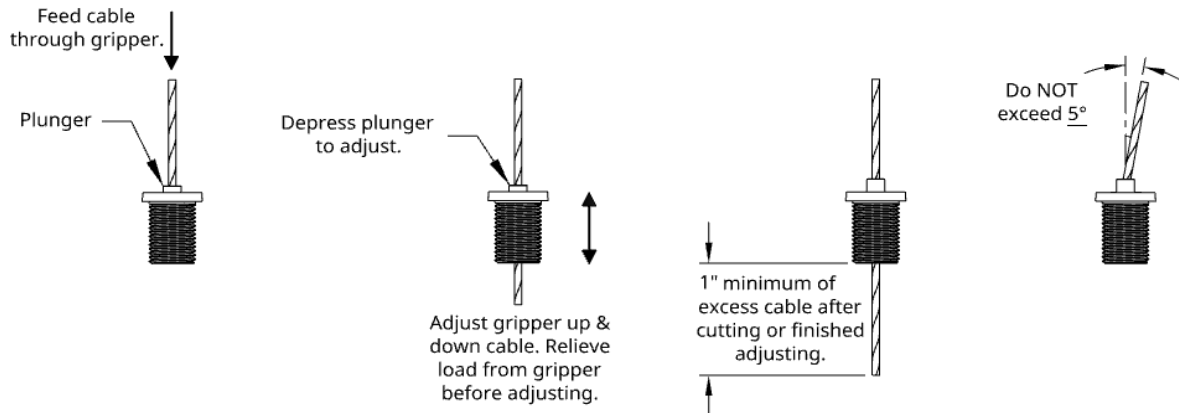

### SUBMITTAL INFORMATION:

#### MATERIAL

- Housing, Pressure Plate, & Plunger Release: UNS C3600 Brass      Plating: Bright Nickel
- Ball Bearings: Brass
- Spring: 304 Stainless Steel

7x7 Galvanized Cable		
Cable Diameter	3/64"	1/16"
Working Load Limit (lbs)	30	60

7x7 304 Stainless Steel Cable		
Cable Diameter	3/64"	1/16"
Working Load Limit (lbs)	25	50

**\*WLL 5:1 Safety Factor**

**NOT** suitable for indoor pools or other chlorinated environments.

