

G24SE-1420I

G24 GRIPPERS

Tool less adjustable cable suspension hardware for quick and accurate installs. For multiple suspension applications including lighting, signage, art, acoustical, and displays.

FEATURES/BENEFITS:

- 1) Fast & easy installation. Adjusts quickly by hand. 2) Strength & security. As load increases mechanism grips tighter to cable. 5:1 safety factor. 3) All metal parts. No plastic components. 4) Great Looks. Nickel plated machined brass.



DIMENSIONS:

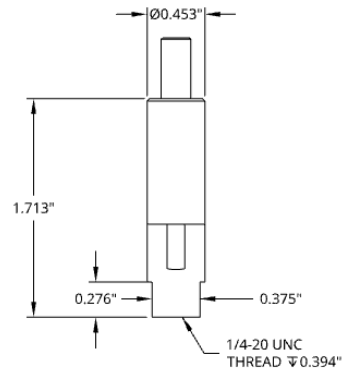

INSTALLATION:

Feed cable through gripper.



Depress plunger to adjust.

Adjust gripper up & down cable. Relieve load from gripper before adjusting.



Do NOT exceed 5°

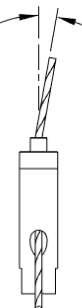

1" minimum of excess cable after cutting or finished adjusting.

SUBMITTAL INFORMATION:

MATERIAL

- Housing, Top Cap & Plunger Release: UNS C3600 Brass Plating: Bright Nickel
- Ball Bearings: Brass
- Spring: 304 Stainless Steel

7x7 Galvanized Cable		
Cable Diameter	5/64"	3/32"
Working Load Limit (lbs)	90	120

7x7 304 Stainless Steel Cable		
Cable Diameter	5/64"	3/32"
Working Load Limit (lbs)	75	100

***WLL 5:1 Safety Factor**

NOT suitable for indoor pools or other chlorinated environments.